



# FANUC

## *Compatible Cables and Accessories*



**Monclova:** Tel. (866) 633 37 21 / 632 90 7

**Monterrey:** Tel. (81) 1001-6958

**Contacto:** [Ventas@brokable.com](mailto:Ventas@brokable.com) / [Contacto@brokable.com](mailto:Contacto@brokable.com)

[www.brokable.com](http://www.brokable.com)

<b>18-10 and 22-22 Connector Specifications .....</b>	<b>pag</b>	<b>2</b>
Motor Views - Exit Power Cables .....	"	3
<i>Technical Specifications - Power Cables .....</i>	"	3
Power cables .....	pag	4
Power Cables .....	"	4
Extension Power cables .....	"	12
Brake cables .....	pag	16
Brake cables .....	"	16
Extension Brake cables .....	"	17
Fan cables .....	pag	18
Feedback cables .....	pag	19
Feedback cables .....	"	19
Extension Feedback cables .....	"	20
I/O Link cables .....	pag	22
I/O Link cables .....	"	22
Extension I/O Link cables .....	"	23
Electrical Cabinet cables .....	pag	24
Operator's Panel cables .....	pag	28

***Fanuc article descriptions into the catalogue are registered trademarks of Fanuc, and are for reference purposes only***

## 18-10 AND 22-22 CONNECTOR SPECIFICATIONS

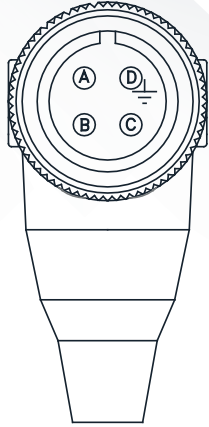

Standard  
0°

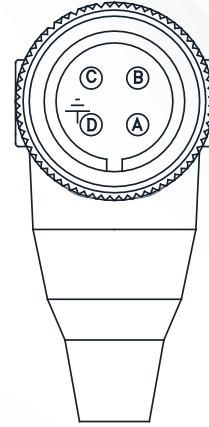
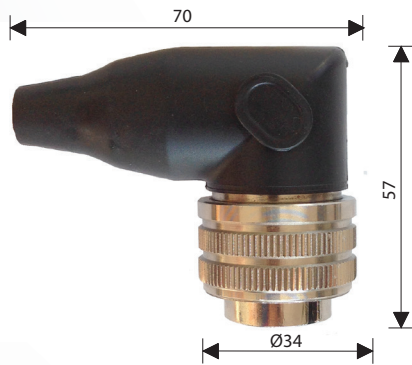

-V  
180°

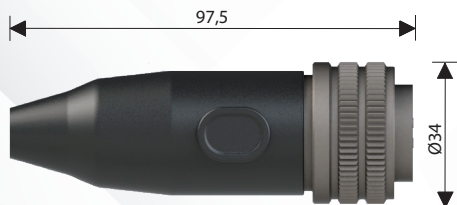
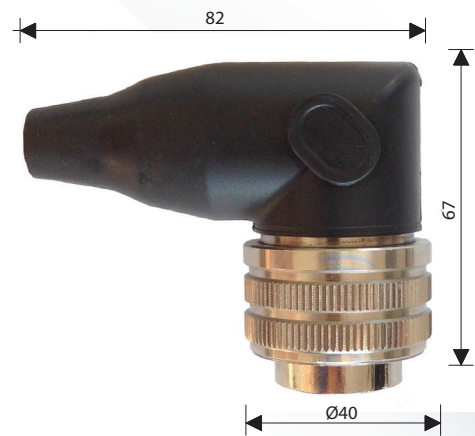

## 18-10 AND 22-22 CONNECTOR SPECIFICATIONS

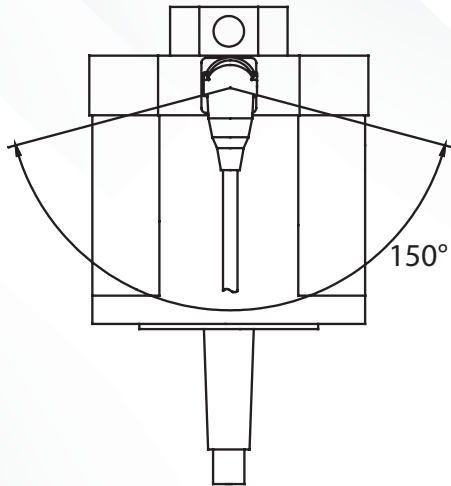

Standard  
0°

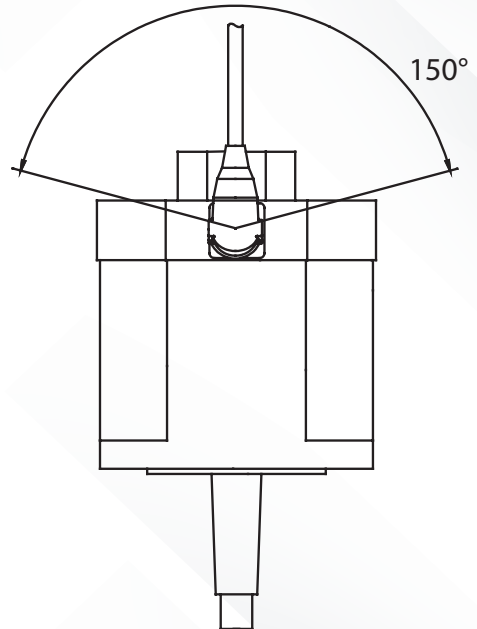

-V  
180°

TECHNICAL SPECIFICATIONS	18-10	22-22
Reference standards	MIL-C-5010	MIL-C-5010
Protection Class	IP67 (se accoppiato)	IP67 (if mated)
Temperature Range	-40°C / +100°C	-40°C / +100°C
Nominal Currents	23 A	46 A
Maximum Section Conductor	3 mmq	6 mmq
Nominal Voltage	500 V	500 V
Contact Resistance	≤ 5mΩ	≤ 5mΩ

### ORIENTATION

The orientation of exit cable can be customized, in relation to satisfy a custom.

*In top, are reported the possible configurations, with a letter -V, is contained in a description of Reference Number.*

MATERIALS	18-10 and 22-22
Cabinet	ZnAl4Cu1 (tratt. al Ni)
Coupling Nut	AL 2011 (tratt. al Ni)
Locking / Thread	1,1250 - 18 UNEF
Insulation Holder	ZnAl4Cu1 (tratt. al Ni)
Insulation Body	In accord to UL94V0
Contacts	(tratt. al Ag)
Sealings	NBR
Housing Rings	AlSi302
Shielding	CuZn39Pb3
Moulding Cover	Poliammide / Polyamide In accord to UL94V0



### DIN EN 61984 - VDE 0627

Grado di Inquinamento	Pollution Degree	3 (IEC 60060-1)
Categoria di Sovratensione	Over Voltage Category	II
Utilizzo ad Altitudine Massima	Max Operation Altitude	2000 m

### MECHANICAL SPECIFICATION

Vibration resistance

Frequency: 10-500Hz, single amplitude 0,6mm, acceleration: 98m/sq, 3 hours over 3 axes, with connector mated

Shock resistance

Acceleration: 490m/sq, 11ms, Half sine wave, Waveform, 3 runs in 3 axes, with connector mated



## FANUC COMPATIBLE - POWER CABLES



Reference Number	Description	Application
BK-1-000-002-1-001	LX660-4078-T451/LxRx3	FIXED
BK-1-000-002-2-001	LX660-4078-T451/LxRx3	DYNAMIC
BK-1-000-002-1-002	LX660-4078-T451/LxRx3-V	FIXED
BK-1-000-002-2-002	LX660-4078-T451/LxRx3-V	DYNAMIC



Reference Number	Description	Application
BK-1-000-002-1-005	LX660-4078-T450/LxRx3	FIXED
BK-1-000-002-2-005	LX660-4078-T450/LxRx3	DYNAMIC

## FANUC COMPATIBLE - POWER CABLES

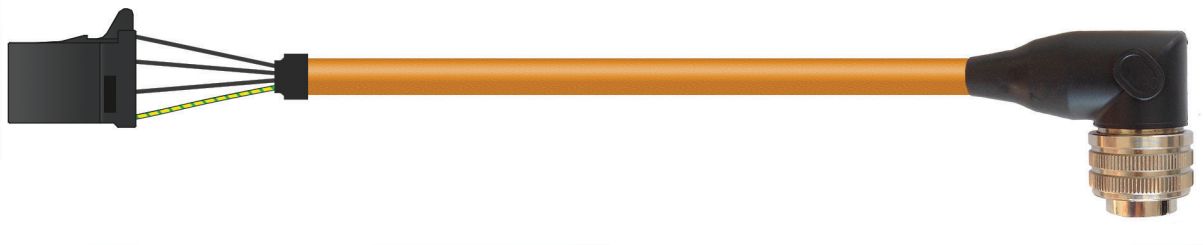

Reference Number	Description	Application
BK-1-000-002-1-006	LX660-4078-T453/LxRx3	FIXED
BK-1-000-002-2-006	LX660-4078-T453/LxRx3	DYNAMIC
BK-1-000-002-1-007	LX660-4078-T453/LxRx3-V	FIXED
BK-1-000-002-2-007	LX660-4078-T453/LxRx3-V	DYNAMIC



Reference Number	Description	Application
BK-1-000-002-1-010	LX660-4078-T452/LxRx3	FIXED
BK-1-000-002-2-010	LX660-4078-T452/LxRx3	DYNAMIC

## FANUC COMPATIBLE - POWER CABLES



Reference Number	Description	Application
BK-1-000-002-1-016	LX660-8077-T451/LxRx3	FIXED
BK-1-000-002-2-016	LX660-8077-T451/LxRx3	DYNAMIC
BK-1-000-002-1-017	LX660-8077-T451/LxRx3-V	FIXED
BK-1-000-002-2-017	LX660-8077-T451/LxRx3-V	DYNAMIC



Reference Number	Description	Application
BK-1-000-002-1-020	LX660-8077-T450/LxRx3	FIXED
BK-1-000-002-2-020	LX660-8077-T450/LxRx3	DYNAMIC

## FANUC COMPATIBLE - POWER CABLES

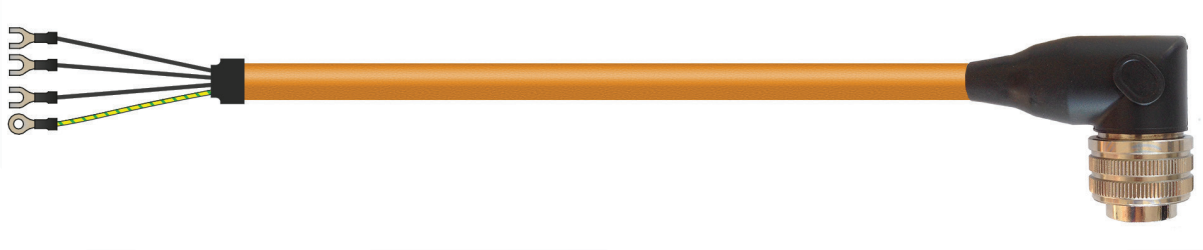

Reference Number	Description	Application
BK-1-000-002-1-021	LX660-8077-T453/LxRx3	FIXED
BK-1-000-002-2-021	LX660-8077-T453/LxRx3	DYNAMIC
BK-1-000-002-1-022	LX660-8077-T453/LxRx3-V	FIXED
BK-1-000-002-2-022	LX660-8077-T453/LxRx3-V	DYNAMIC



Reference Number	Description	Application
BK-1-000-002-1-025	LX660-8077-T452/LxRx3	FIXED
BK-1-000-002-2-025	LX660-8077-T452/LxRx3	DYNAMIC



## FANUC COMPATIBLE - POWER CABLES



Reference Number	Description	Application
BK-1-000-002-1-011	LX660-4078-T471/LxRx3	FIXED
BK-1-000-002-2-011	LX660-4078-T471/LxRx3	DYNAMIC
BK-1-000-002-1-012	LX660-4078-T471/LxRx3-V	FIXED
BK-1-000-002-2-012	LX660-4078-T471/LxRx3-V	DYNAMIC

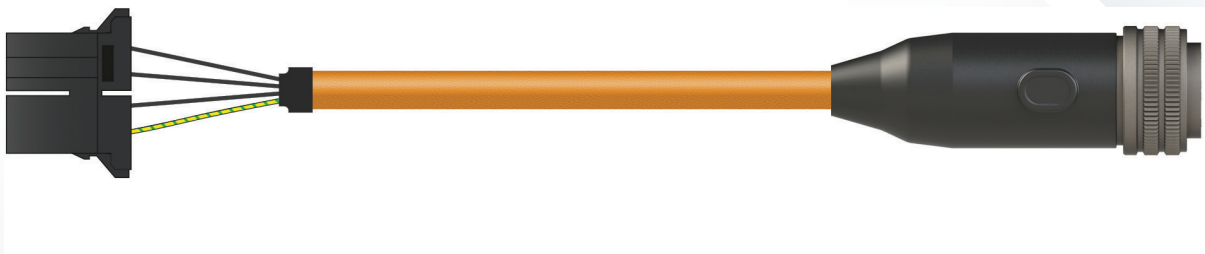

Reference Number	Description	Application
BK-1-000-002-1-015	LX660-4078-T470/LxRx3	FIXED
BK-1-000-002-2-015	LX660-4078-T470/LxRx3	DYNAMIC

## FANUC COMPATIBLE - POWER CABLES



Reference Number	Description	Application
BK-1-000-002-1-031	LX660-8077-T471/LxRx3	FIXED
BK-1-000-002-2-031	LX660-8077-T471/LxRx3	DYNAMIC
BK-1-000-002-1-032	LX660-8077-T471/LxRx3-V	FIXED
BK-1-000-002-2-032	LX660-8077-T471/LxRx3-V	DYNAMIC

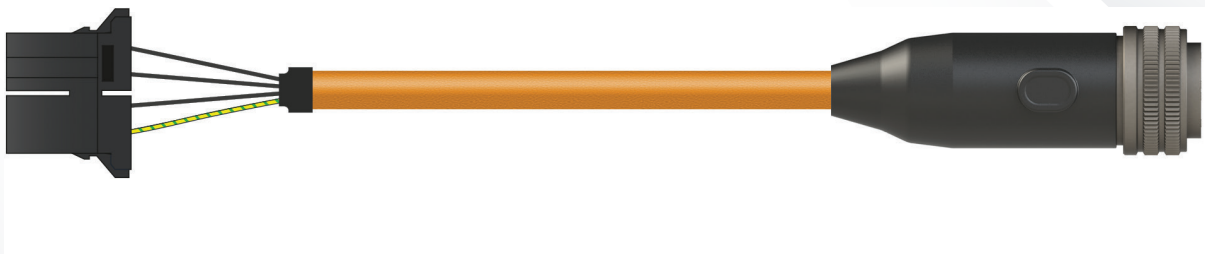

Reference Number	Description	Application
BK-1-000-002-1-035	LX660-8077-T470/LxRx3	FIXED
BK-1-000-002-2-035	LX660-8077-T470/LxRx3	DYNAMIC

## FANUC COMPATIBLE - POWER CABLES



Reference Number	Description	Application
BK-1-000-002-1-036	LX660-8077-T473/LxRx3	FIXED
BK-1-000-002-2-036	LX660-8077-T473/LxRx3	DYNAMIC
BK-1-000-002-1-037	LX660-8077-T473/LxRx3-V	FIXED
BK-1-000-002-2-037	LX660-8077-T473/LxRx3-V	DYNAMIC

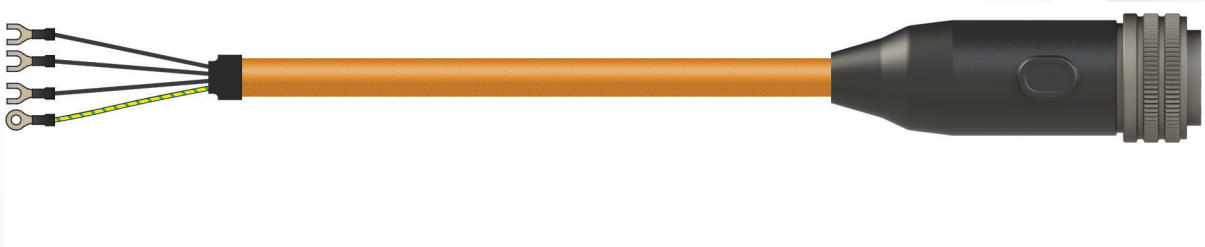

Reference Number	Description	Application
BK-1-000-002-1-040	LX660-8077-T472/LxRx3	FIXED
BK-1-000-002-2-040	LX660-8077-T472/LxRx3	DYNAMIC

## FANUC COMPATIBLE - POWER CABLES

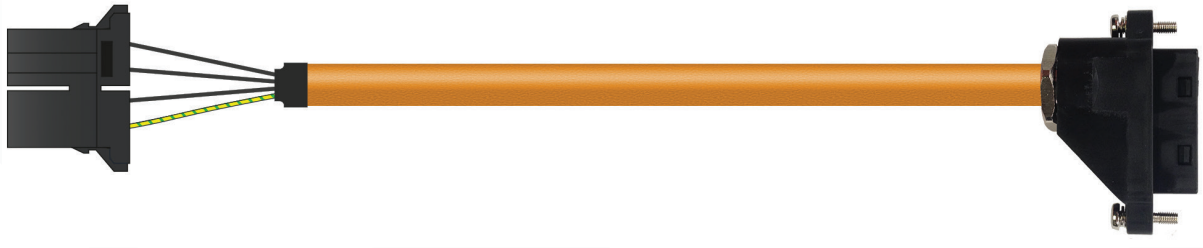

Reference Number	Description	Application
BK-1-000-002-1-258	LX660-8077-T308/LxRx3	FIXED
BK-1-000-002-2-258	LX660-8077-T308/LxRx3	DYNAMIC



Reference Number	Description	Application
BK-1-000-002-1-212	LX660-8077-T262/LxRx3	FIXED
BK-1-000-002-2-212	LX660-8077-T262/LxRx3	DYNAMIC



## FANUC COMPATIBLE - EXTENSION POWER CABLES

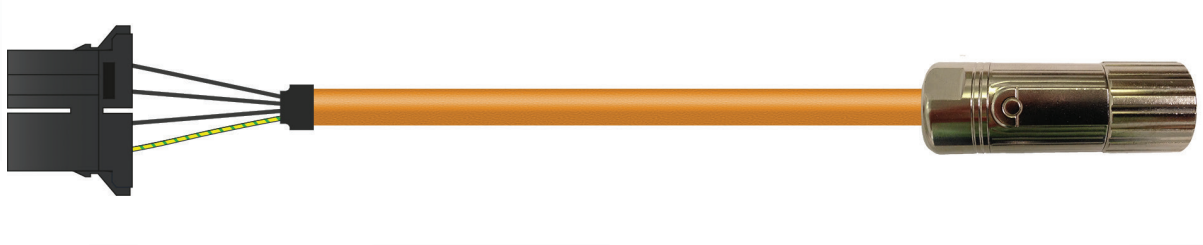

Reference Number	Description	Application
BK-1-000-002-1-245	LX660-8077-T296/LxRx3	FIXED
BK-1-000-002-2-245	LX660-8077-T296/LxRx3	DYNAMIC



Reference Number	Description	Application
BK-1-000-002-1-246	LX660-8077-T295/LxRx3	FIXED
BK-1-000-002-2-246	LX660-8077-T295/LxRx3	DYNAMIC

## FANUC COMPATIBLE - EXTENSION POWER CABLES



Reference Number	Description	Application
BK-1-000-002-1-026	LX660-8077-T455/LxRx3	FIXED
BK-1-000-002-2-026	LX660-8077-T455/LxRx3	DYNAMIC
BK-1-000-002-1-027	LX660-8077-T455/LxRx3-V	FIXED
BK-1-000-002-2-027	LX660-8077-T455/LxRx3-V	DYNAMIC

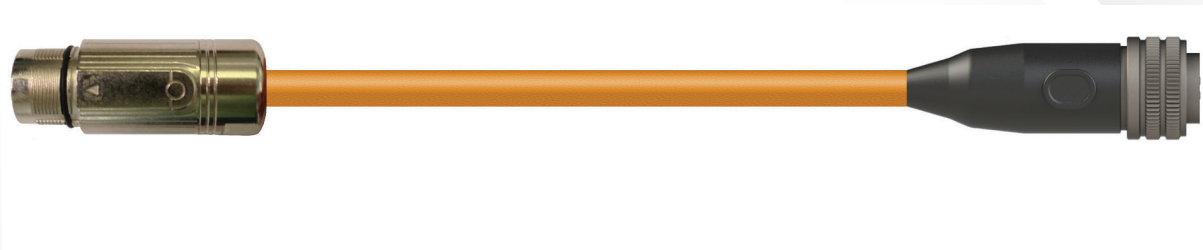

Reference Number	Description	Application
BK-1-000-002-1-030	LX660-8077-T454/LxRx3	FIXED
BK-1-000-002-2-030	LX660-8077-T454/LxRx3	DYNAMIC

## FANUC COMPATIBLE - EXTENSION POWER CABLES

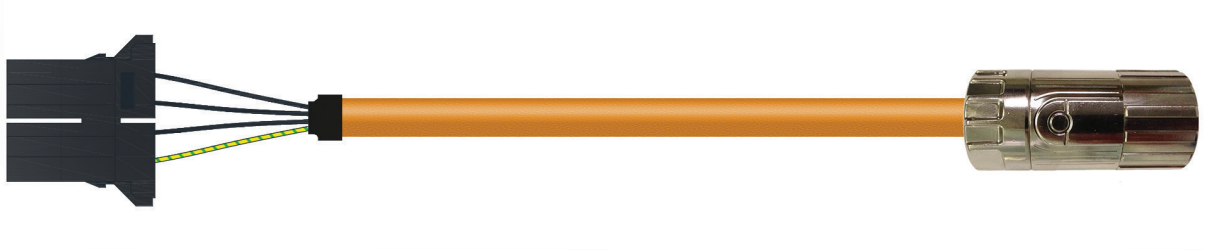

Reference Number	Description	Application
BK-1-000-002-1-248	LX660-8077-T298/LxRx3	FIXED
BK-1-000-002-2-248	LX660-8077-T298/LxRx3	DYNAMIC

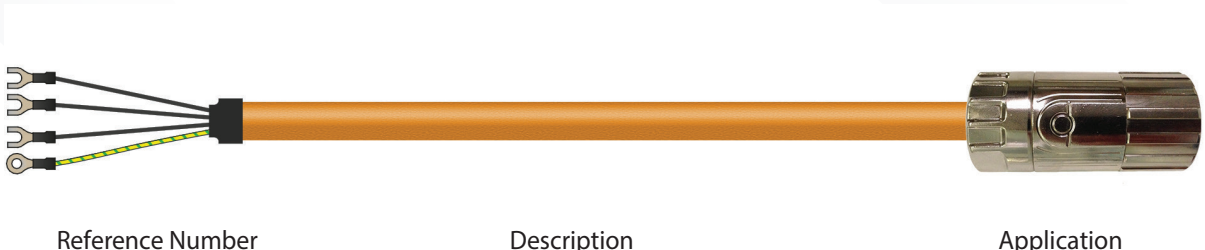

Reference Number	Description	Application
BK-1-000-002-1-247	LX660-8077-T297/LxRx3	FIXED
BK-1-000-002-2-247	LX660-8077-T297/LxRx3	DYNAMIC

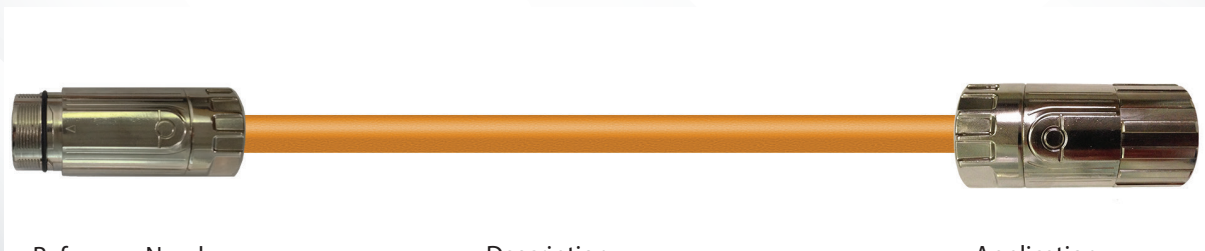

Reference Number	Description	Application
BK-1-000-002-1-361	LX660-8077-T411/LxRx3	FIXED
BK-1-000-002-2-361	LX660-8077-T411/LxRx3	DYNAMIC

## FANUC COMPATIBLE - EXTENSION POWER CABLES



Reference Number	Description	Application
BK-1-000-002-1-041	LX660-8077-T475/LxRx3	FIXED
BK-1-000-002-2-041	LX660-8077-T475/LxRx3	DYNAMIC
BK-1-000-002-1-042	LX660-8077-T475/LxRx3-V	FIXED
BK-1-000-002-2-042	LX660-8077-T475/LxRx3-V	DYNAMIC

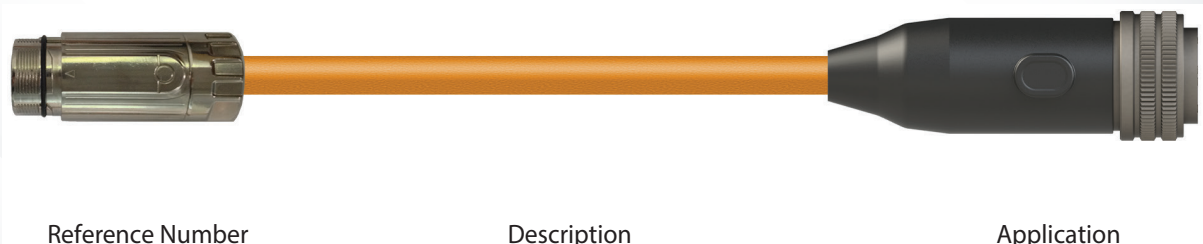

Reference Number	Description	Application
BK-1-000-002-1-045	LX660-8077-T474/LxRx3	FIXED
BK-1-000-002-2-045	LX660-8077-T474/LxRx3	DYNAMIC



## FANUC COMPATIBLE - BRAKE CABLES



Reference Number	Description	Application
BK-1-000-002-1-230	LX660-8077-T280/LxRx3	FIXED
BK-1-000-002-2-230	LX660-8077-T280/LxRx3	DYNAMIC

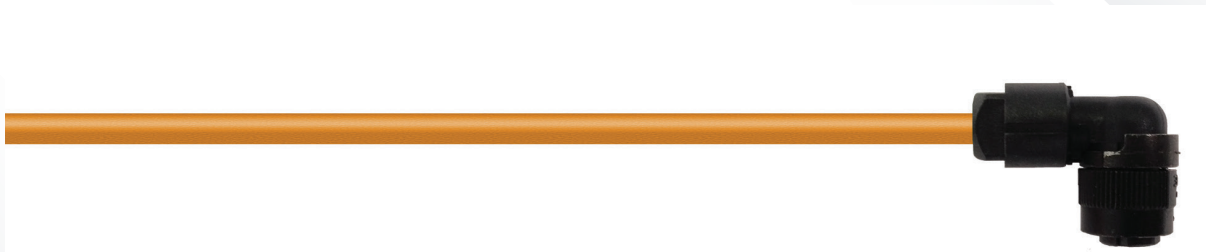

Reference Number	Description	Application
BK-1-000-002-1-231	LX660-8077-T281/LxRx3	FIXED
BK-1-000-002-2-231	LX660-8077-T281/LxRx3	DYNAMIC

## FANUC COMPATIBLE - EXTENSION BRAKE CABLES



Reference Number	Description	Application
BK-1-000-002-1-262	LX660-8077-T312/LxRx3	FIXED
BK-1-000-002-2-262	LX660-8077-T312/LxRx3	DYNAMIC



Reference Number	Description	Application
BK-1-000-002-1-261	LX660-8077-T311/LxRx3	FIXED
BK-1-000-002-2-261	LX660-8077-T311/LxRx3	DYNAMIC



Reference Number	Description	Application
BK-1-000-002-1-260	LX660-8077-T310/LxRx3	FIXED
BK-1-000-002-2-260	LX660-4078-T310/LxRx3	DYNAMIC

## FANUC COMPATIBLE - FAN CABLES



Reference Number	Description	Application
BK-1-000-002-1-254	LX660-8077-T304/LxRx3	FIXED
BK-1-000-002-2-254	LX660-8077-T304/LxRx3	DYNAMIC



Reference Number	Description	Application
BK-1-000-002-1-255	LX660-8077-T305/LxRx3	FIXED
BK-1-000-002-2-255	LX660-8077-T305/LxRx3	DYNAMIC

## FANUC COMPATIBLE - FEEDBACK CABLES

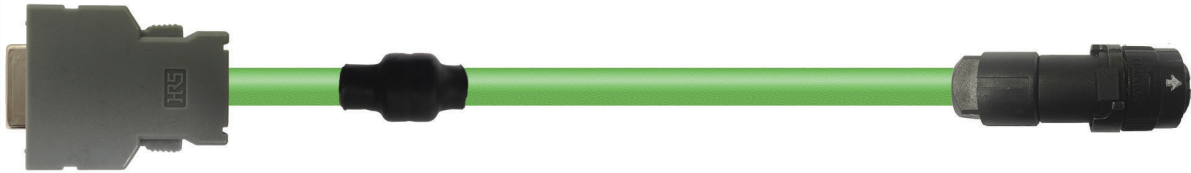

Reference Number	Description	Application
BK-1-000-002-1-596	LX660-4077-T296/LxRx3	FIXED
BK-1-000-002-2-596	LX660-4077-T296/LxRx3	DYNAMIC

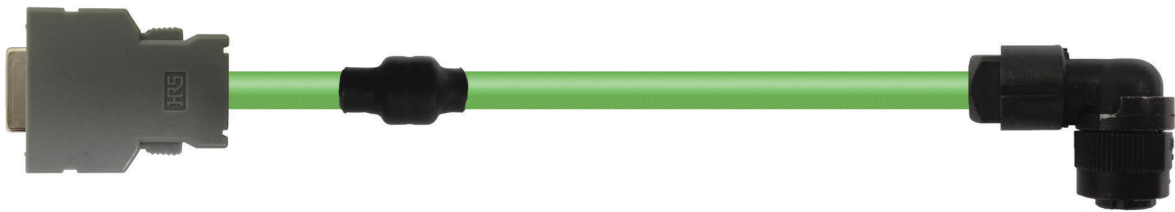

Reference Number	Description	Application
BK-1-000-002-1-597	LX660-4077-T297/LxRx3	FIXED
BK-1-000-002-2-597	LX660-4077-T297/LxRx3	DYNAMIC



## FANUC COMPATIBLE - EXTENSION FEEDBACK CABLES



Reference Number	Description	Application
BK-1-000-002-1-604	LX660-4077-T304/LxRx3	FIXED
BK-1-000-002-2-604	LX660-4077-T304/LxRx3	DYNAMIC

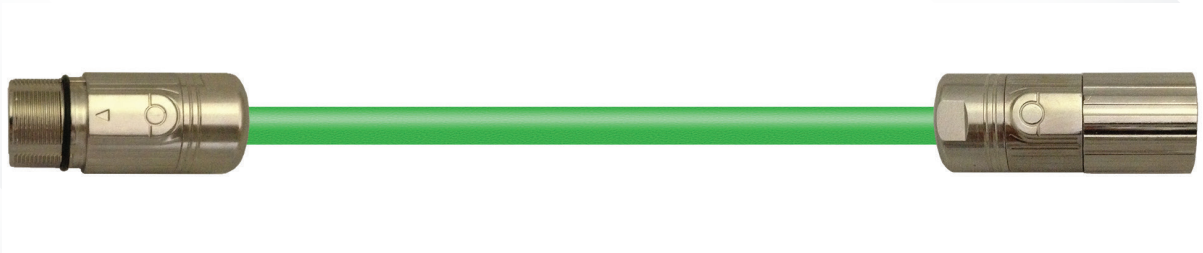

Reference Number	Description	Application
BK-1-000-002-1-641	LX660-4077-T341/LxRx3	FIXED
BK-1-000-002-2-641	LX660-4077-T341/LxRx3	DYNAMIC

## FANUC COMPATIBLE - EXTENSION FEEDBACK CABLES



Reference Number	Description	Application
BK-1-000-002-1-603	LX660-4077-T303/LxRx3	FIXED
BK-1-000-002-2-603	LX660-4077-T303/LxRx3	DYNAMIC



Reference Number	Description	Application
BK-1-000-002-1-602	LX660-4077-T302/LxRx3	FIXED
BK-1-000-002-2-602	LX660-4077-T302/LxRx3	DYNAMIC

## FANUC COMPATIBLE - I/O LINK CABLES



Reference Number	Description	Application
BK-1-000-002-1-750	LX660-2007-T010/LxRx3	FIXED
BK-1-000-002-2-750	LX660-2007-T010/LxRx3	DYNAMIC
BK-1-000-002-1-751	LX660-2007-T011/LxRx3	FIXED
BK-1-000-002-2-751	LX660-2007-T011/LxRx3	DYNAMIC
BK-1-000-002-1-752	LX660-2007-T012/LxRx3	FIXED
BK-1-000-002-2-752	LX660-2007-T012/LxRx3	DYNAMIC
BK-1-000-002-1-753	LX660-2007-T013/LxRx3	FIXED
BK-1-000-002-2-753	LX660-2007-T013/LxRx3	DYNAMIC
BK-1-000-002-1-754	LX660-2007-T014/LxRx3	FIXED
BK-1-000-002-2-754	LX660-2007-T014/LxRx3	DYNAMIC
BK-1-000-002-1-755	LX660-2007-T015/LxRx3	FIXED
BK-1-000-002-2-755	LX660-2007-T015/LxRx3	DYNAMIC

## FANUC COMPATIBLE - EXTENSION I/O LINK CABLES



Reference Number	Description	Application
BK-1-000-002-1-756	LX660-2007-T016/LxRx3	FIXED
BK-1-000-002-2-756	LX660-2007-T016/LxRx3	DYNAMIC



Reference Number	Description	Application
BK-1-000-002-1-757	LX660-2007-T017/LxRx3	FIXED
BK-1-000-002-2-757	LX660-2007-T017/LxRx3	DYNAMIC



Reference Number	Description	Application
BK-1-000-002-0-001	LX660-8932-D001	ACCESSORY
BK-1-000-002-0-002	LX660-8932-D002	ACCESSORY



## COMPATIBLE - ELECTRICAL CABINET CABLES



Reference Number	Description	Application
BK-1-000-002-1-820	LX660-2077-T220/LxRx3	CABINET
BK-1-000-002-1-821	LX660-2077-T221/LxRx3	CABINET
BK-1-000-002-1-240	LX660-8077-T290/LxRx3	CABINET
BK-1-000-002-1-292	LX660-8077-T342/LxRx3	CABINET
BK-1-000-002-1-293	LX660-8077-T343/LxRx3	CABINET



Reference Number	Description	Application
BK-1-000-002-1-822	LX660-2077-T222/LxRx3	CABINET
BK-1-000-002-1-823	LX660-2077-T223/LxRx3	CABINET
BK-1-000-002-1-239	LX660-8077-T289/LxRx3	CABINET

## FANUC COMPATIBLE - ELECTRICAL CABINET CABLES



Reference Number

Description

Application

BK-1-000-002-1-805

LX660-2077-T205/LxRx3

CABINET



Reference Number

Description

Application

BK-1-000-002-1-808

LX660-2077-T208/LxRx3

CABINET



Reference Number

Description

Application

BK-1-000-002-1-131

LX660-8007-T011/LxRx3

CABINET

## FANUC COMPATIBLE - ELECTRICAL CABINET CABLES



Reference Number	Description	Application
BK-1-000-002-1-405	LX660-8018-T005/LxRx3	CABINET
BK-1-000-002-1-423	LX660-8018-T023/LxRx3	CABINET
BK-1-000-002-1-182	LX660-8077-T232/LxRx3	CABINET
BK-1-000-002-1-184	LX660-8077-T234/LxRx3	CABINET
BK-1-000-002-1-185	LX660-8077-T235/LxRx3	CABINET
BK-1-000-002-1-269	LX660-8077-T319/LxRx3	CABINET
BK-1-000-002-1-271	LX660-8077-T321/LxRx3	CABINET



Reference Number	Description	Application
BK-1-000-002-1-769	LX660-2018-T009/LxRx3	CABINET
BK-1-000-002-1-770	LX660-2018-T010/LxRx3	CABINET
BK-1-000-002-1-440	LX660-8024-T010/LxRx3	CABINET
BK-1-000-002-1-460	LX660-8030-T010/LxRx3	CABINET

## FANUC COMPATIBLE - ELECTRICAL CABINET CABLES



Reference Number	Description	Application
BK-1-000-002-1-355	LX660-8077-T405/LxRx3	CABINET
BK-1-000-002-1-356	LX660-8077-T406/LxRx3	CABINET



Reference Number	Description	Application
BK-1-000-002-1-373	LX660-8078-T003/LxRx3	CABINET



Reference Number	Description	Application
BK-1-000-002-1-374	LX660-8078-T004/LxRx3	CABINET



## FANUC COMPATIBLE - OPERATOR'S PANEL CABLES

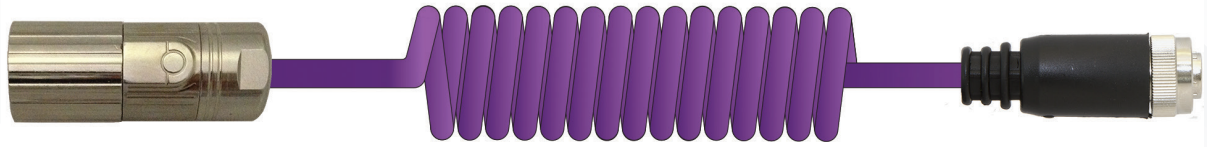

Reference Number	Description	Application
BK-1-000-002-2-943	LX660-4024-T023/LxRx3	HANDWHEEL
BK-1-000-002-2-944	LX660-4024-T025/LxRx3	HANDWHEEL



Reference Number	Description	Application
BK-1-000-002-2-946	LX660-4024-T026/LxRx3	HANDWHEEL
BK-1-000-002-2-947	LX660-4024-T027/LxRx3	HANDWHEEL
BK-1-000-002-2-948	LX660-4024-T028/LxRx3	HANDWHEEL



Reference Number	Description	Application
BK-1-000-002-0-003	LX02B-0100-K026	ACCESSORY

## FANUC COMPATIBLE - OPERATOR PANEL I/O

### Standard Version

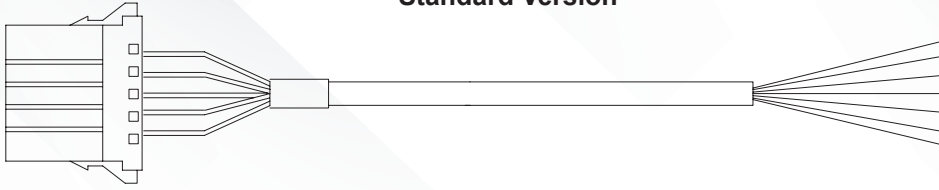

Reference Number

Description

Application

BK-5-000-002-0-003

CM68 - CM69

I/O OPERATOR PANNELL

### Terminal block Version

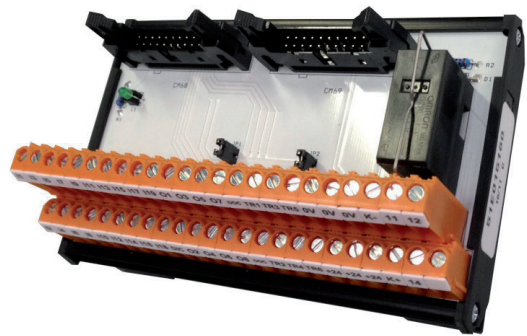
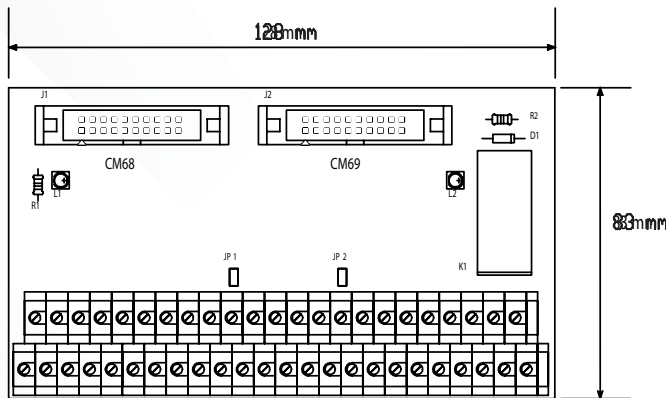

Reference Number

Description

BK-5-000-002-0-001

OPERATOR PANEL I/O  
I/O PANNELLO OPERATORE

Cable and terminal no salabile separately  
Cavo e morsettiera non vendibili separatamente

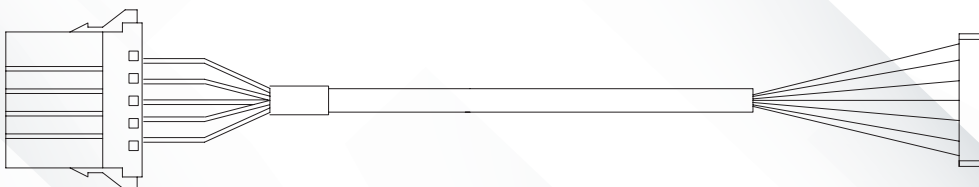

Reference Number

Description

Application

BK-5-000-002-0-002

CM68 - CM69

I/O OPERATOR PANNELL





**Monclova**

Tel. (866) 633 37 21 / 632 90 7

**Monterrey**

Tel. (81) 1001-6958

**Contacto**

Ventas@brokable.com

Contacto@brokable.com

[www.brokable.com](http://www.brokable.com)