

Technical Characteristics

Part Number

Han 24B Kit

Hood	Side Entry
Housing	Double Lever Bulkhead
Material	Die Cast Aluminum
IP / NEMA	IP65 / 4, 4x, 12
Temp Rating	-40 to +125C
Cable Gland	M32 Metal
Cable Diameter	13-20mm / 18-25mm
Insert	Han 24E, 24+GND
Screw Terminals	18-14AWG
Wire Strip Length	7.5mm
Mating Cycles	> 500
Flammability	V-0

Electrical Characteristics

Rated Current	16amps
Rated Voltage	600V UL
Rated Impulse Voltage	6kV



10 33 024 0000

UL508



Drawings and Assembly Information

Dimensions in mm

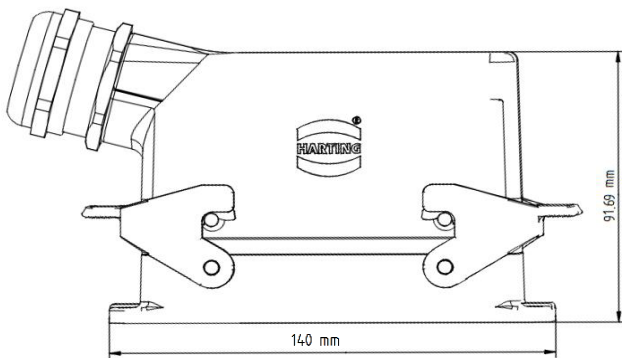

Tooling and Torque Values		
Type	Tool	Torque (Nm)
Terminal Screws (M3)	PH1 or Slotted 0.6 x 3.5	0.50
Fixing Screw (M3)	PH2 or Slotted 0.6 x 3.5	0.50
Mounting Screws (M4 recommended)	-	0.8...1.0
Cable Gland (M32)	SW 40	15

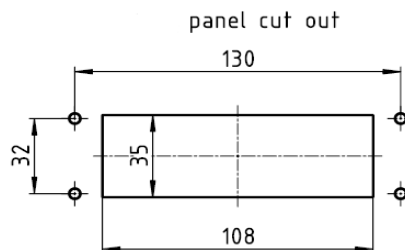

Kit Contents	
Male Insert	09 33 024 2601
Female insert	09 33 024 2701
Housing	09 30 024 0301
Hood	19 30 024 1522
Cable Gland	19 00 000 5095

For further information, please reach out to techsupportUS@HARTING.com